



# BRIEF INFORMATION

## Rota LED beacon

- Rotating or flashing LED light function
- Long lifetime
- Flat and compact design
- Low current consumption, high efficiency

### PRODUCT FEATURES

The Rota LED is available with a rotating or flashing light function. No moving parts are required for these functions – so no wear and maximum reliability. Since LEDs are maintenance-free, they do not cause any additional costs for spare parts or maintenance. Downtime is reduced to a minimum. The shock-absorbent rubber base makes it extremely resistant to vibrations and therefore especially suitable for demanding applications. The shock-resistant dome made of polycarbonate protects against impacts (e.g. from branches). Three different installation options i.a.w. DIN 14620 and SAE ensure a solution for every application: Permanent installation (Ø 130 mm and Ø 150 mm), pipe socket and magnetic attachment.



Operating voltage 10 – 30 V



Polarity reversal protection – fully protects electronics, even if connecting leads are swapped around



IP X9K - Resistant to high-pressure cleaners – protection against water during high pressure / steam cleaning

# TECHNICAL DETAILS

## Technical data

Rated voltage ( $U_N$ )	Multi-voltage
Operating voltage ( $U_O$ )	10–30 V
Total current consumption Rotating Flashing	approx. 0.8 A (12 V), approx. 0.4 A (24 V) approx. 0.7 A (12 V), approx. 0.35 A (24 V)
Maximum power consumption Rotating Flashing	Approx. 9 W approx. 12 W
Dome	Polycarbonate
Operating position	Upright
Temperature range	-40°C to +60°C
Polarity reversal protection:	yes
Protection class	IP 5K4K, 9K

## Type approval

Interference suppression (CISPR25) Power-controlled Class 5

Approval GGVSE / ADR  
SAE J845 class 2

## Rotating light function:

Lighting technology homologation, amber	TA1		R10 046194 R65 003109
---	-----	--	--------------------------

Lighting technology homologation, blue	TB1		R10 046194 R65 003503
--	-----	--	--------------------------

## Flashing function:

Lighting technology homologation, amber	TA1		R10 057696 R65 004154
---	-----	--	--------------------------

Lighting technology homologation, blue	TB1		R10 057696 R65 004155
--	-----	--	--------------------------

Lighting technology homologation, red	TR1		R10 057696 R65 004255
---------------------------------------	-----	--	--------------------------

## Dimensional sketches

Rota LED beacon F

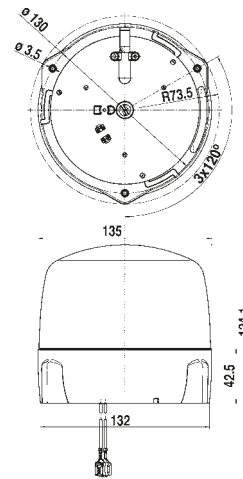

Rota LED beacon FL

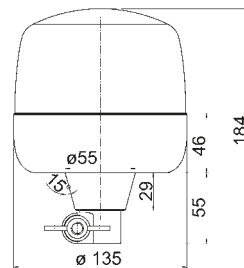



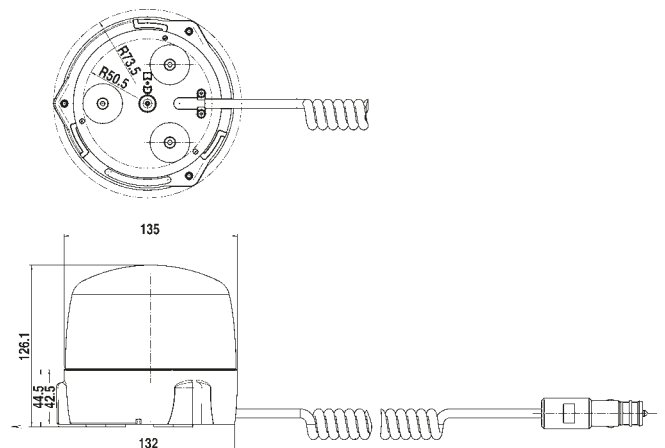





Rota LED beacon M



# OVERVIEW OF RANGE



Product Image	Item number, rotating	Item number, flashing	Description
	2RL 010 979-001	2XD 012 878-001	Rota LED beacon F, amber
	2RL 010 979-101	2XD 012 878-101	Rota LED beacon F, blue
	on request*	2XD 012 878-201*	Rota LED beacon F, red
	2RL 010 979-011	2XD 012 878-011	Rota LED beacon FL, amber
	2RL 010 979-111	2XD 012 878-111	Rota LED beacon FL, blue
	on request*	2XD 012 878-211*	Rota LED beacon FL, red
	2RL 010 979-021	2XD 012 878-021	Rota LED beacon M, amber
	2RL 010 979-121	2XD 012 878-121	Rota LED beacon M, blue
	on request*	2XD 012 878-221*	Rota LED beacon M, red

\* No ECE approval – Use only as far as permitted by legislation. Not approved for road traffic in Germany, Austria and Switzerland.

## Accessories

9EL 181 506-001	Dome (polycarbonate), amber
9EL 181 506-011	Dome (polycarbonate), blue
on request*	Dome (polycarbonate), red

**HELLA KGaA Hueck & Co.**

Rixbecker Straße 75  
59552 Lippstadt, Germany  
Tel.: +49 2941 38-0  
Fax: +49 2941 38-7133  
Internet: [www.hella.com](http://www.hella.com)

© HELLA KGaA Hueck & Co., Lippstadt  
J01143/12.16

Subject to technical and price modifications.

## APPLICATION EXAMPLE

